



CodeX Network Music Player and DAC



CONTENTS

PRODUCT DESCRIPTION.....	3
INVENTORY	3
WHEN SETTING UP	4
SAFETY WARNINGS.....	5
AC POWER CONNECTION.....	6
CONNECTING YOUR EQUIPMENT	7
FRONT PANEL	8
REAR PANEL CONNECTIONS.....	8
NETWORK CONNECTION	9
OUTPUT CONNECTIONS.....	11
HEADPHONES	12
EVERYDAY USE OF YOUR CODEX	12
USER MENUS	13
SETTINGS MENU.....	19
FAVOURITES MENU.....	21
USING THE FRONT PANEL CONTROL	22
USING THE REMOTE CONTROL	23
PLAYING MUSIC FROM AN PORTABLE DEVICE APP OR DESKTOP PROGRAM.....	25
MAINTENANCE	26
FREQUENTLY ASKED QUESTIONS	27
PRODUCT SPECIFICATION.....	28

CodeX Network Music Player

Thank you for buying a Chord Electronics product.

Before you start to enjoy your CodeX, please take a couple of minutes to read how to connect your audio equipment and how to maximise your listening experience.

Product Description

The CodeX is a fully featured digital network player using our state of the art DAC technology. It features uPNP/DLNA access and control and extended HD audio support for the very latest high quality DXD and DSD audio playback. It is compatible with smart phone applications allowing easy remote browsing and playing of networked stored audio.

The digital heart of the CodeX uses the latest generation field programmable gate array device (FPGA) as found in the QuteHD. The FPGA handles all the digital data decoding, clocking, WTA filtering, and the Pulse Array DAC. The improvements to the Pulse Array DAC have been further complimented with improved power supply design and layout giving the very best digital to analogue conversion.

Inventory

As well as your CodeX and this user manual, you should also have received the following items.

1. Remote Control
2. Power cord
3. Chord guarantee registration card
4. RJ45 Network cable

When setting up

To ensure that your CodeX works efficiently and safely, please pay particular attention to the following issues.

ventilation

Your CodeX should have at least 5cm of clear space all around it to ensure a free flow of air at all times. We do not recommend that you place CodeX directly on a carpet. If you have the integra leg system fitted it is recommended that the power amplifiers sit above the CodeX.

AC lead and plug

All Chord equipment comes supplied with the correct power lead and plug. This should be used at all times.

if you need to fit a plug for UK/Europe

Connect the blue wire to the neutral terminal

Connect the brown wire to the live terminal

Connect the yellow/green wire to the earth terminal

if you need to fit a plug for US/Canada

Connect the white wire to the neutral terminal

Connect the black wire to the live terminal

Connect the green to the earth terminal

Earthing issues

In some countries a hum may occur if your CodeX is connected to mains sockets that do not have an earth. If this is the case please ensure that:

1. Your product is connected via a multi-way mains block, which contains an earth point at each socket outlet. This is to ensure that the chassis metalwork of each item is connected together.
2. We recommend that an earthing method for your building be implemented.

Safety Warnings

It is important that your CodeX is earthed at all times via its own mains lead. Failure to do this may be hazardous. The power supply components within the CodeX are designed to operate at lethal voltages and energy levels. Circuit designs that embody these components conform to applicable safety requirements. Precautions must be taken to prevent accidental contact with power-line potentials. Do not connect grounded test equipment.

There are no user serviceable parts within the CodeX Reference Preamplifier. Unauthorised tampering or dismantling of this product will invalidate the warranty and could cause injury.

AC Power connection

The AC power connector on the CodeX is at the back of the unit. Plug the female end (socket) of the power cord into the power connector of the preamplifier, and the male end(plug) of the power cord into AC wall socket or AC extension socket. The CodeX features a universal voltage high frequency power supplied and will operate automatically from 65V to 260V AC, 50 or 60Hz.

For optimum operation it is recommended that the CodeX is connected directly to the wall socket via the power cord provided.

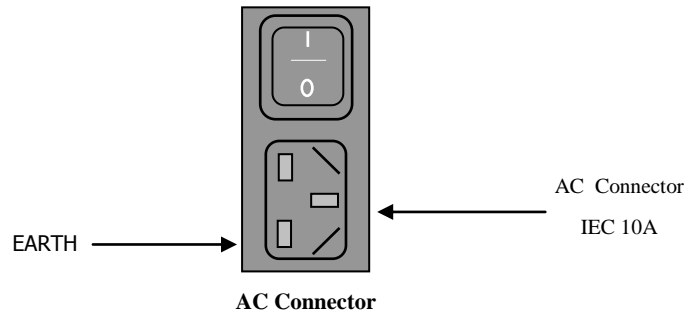

Powering up

Press the rear panel power switch to the on position. The CodeX will run through a boot sequence where the display will show the Chord logo and after about 30 seconds the main menu will be displayed and the unit is ready for use.

Standby mode

Press the standby button on the remote control to enter low power standby mode. Press the standby button again to switch the CodeX back on.

Full Power down

Press the rear panel switch to the off position. The CodeX utilises soft start circuitry so the power can be switched on and off as often as required. There is no need to leave the CodeX permanently switched on.

Connecting your equipment

Chord amplifiers are supplied with and designed to be connected using balanced inputs. The interconnecting cables you use will depend on the available input and output sockets on your other equipment. We have installed unbalanced inputs on all Chord equipment, thus enabling you to mix Chord Electronics and other manufacturer's equipment.

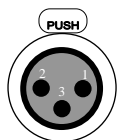

Balanced inputs carry twice the strength of signal of unbalanced inputs and are able to be fed down long lengths of cable with less deterioration of signal. They are also less prone to interference than unbalanced inputs. Balanced inputs have three pins and use XLR style connectors. Pin 1 is earth, pin 2 is positive and pin 3 is negative.



Unbalanced inputs use RCA phono connectors, which are gold plated with teflon high performance dielectric insulators for optimum performance.

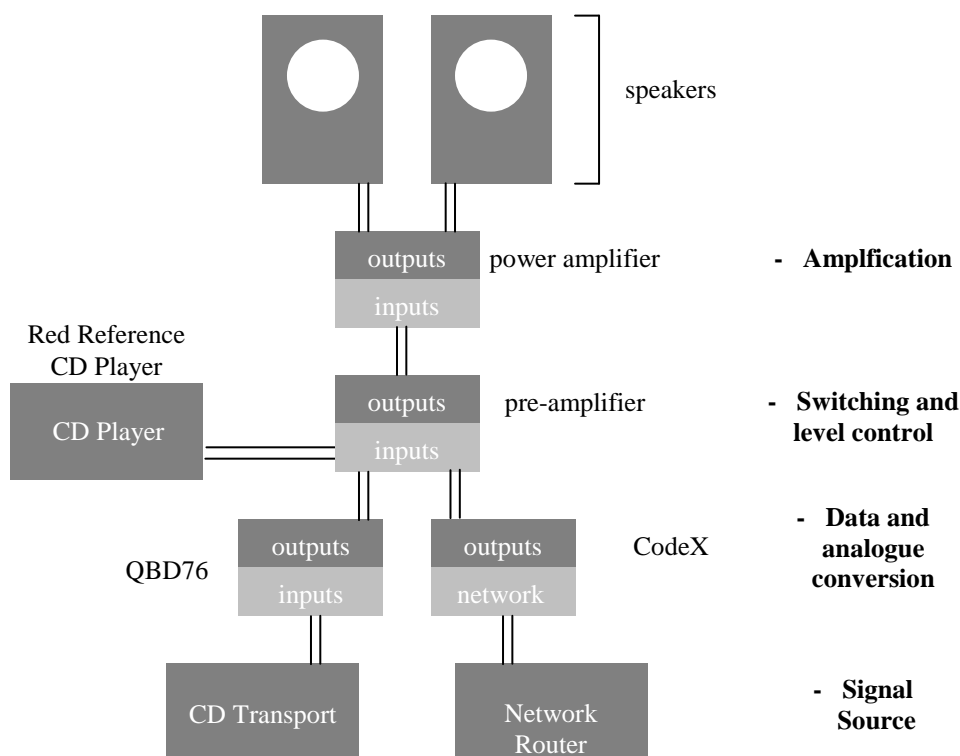

Basic system diagram

Front and Top Panel

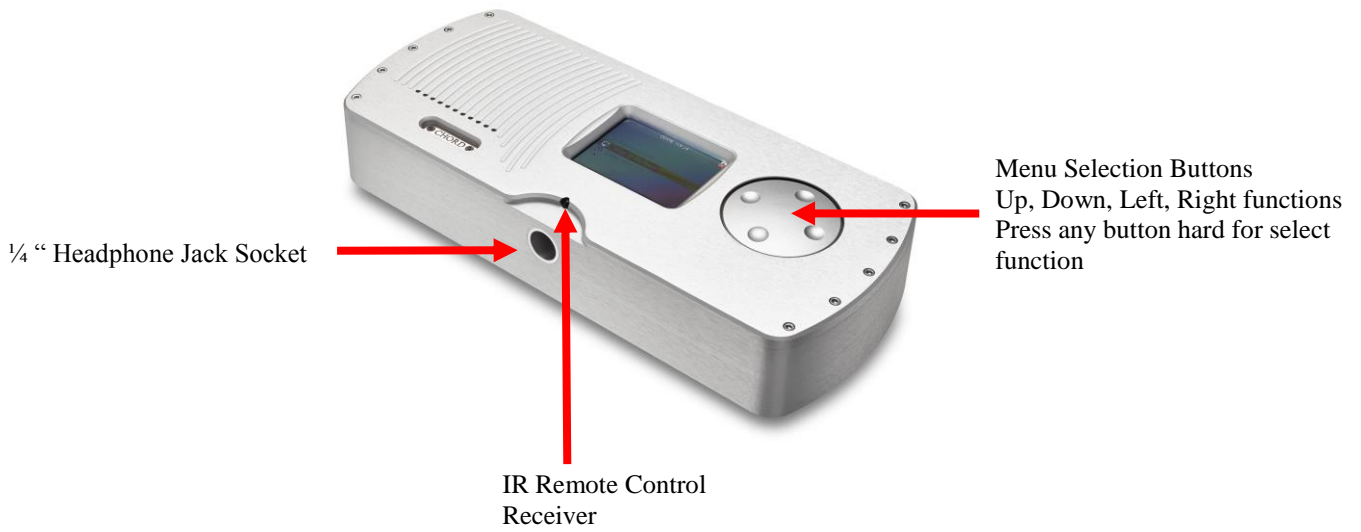

Rear Panel Connections

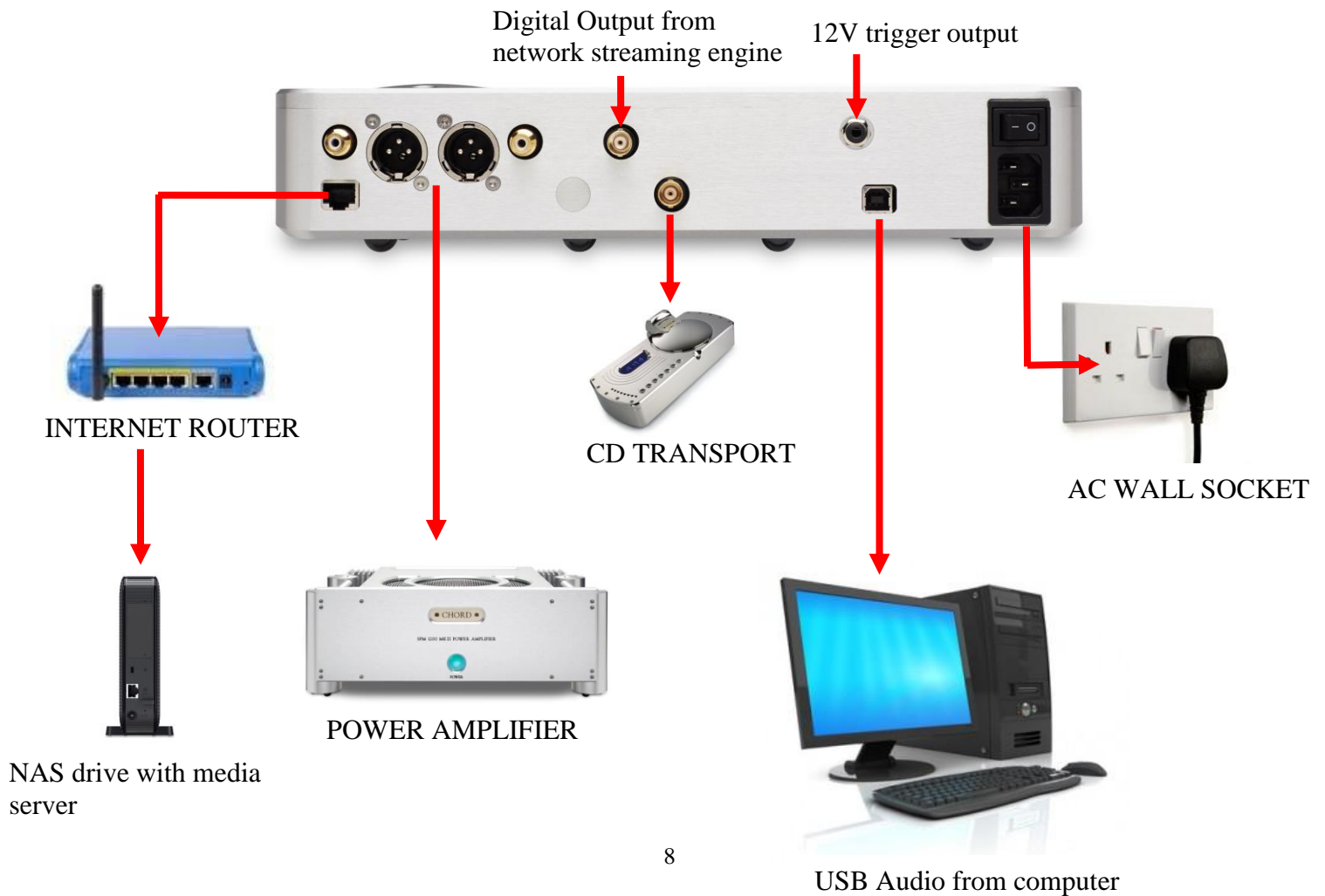

Network Connection

The CodeX has an RJ45 (Cat 5) Ethernet network cable connection. This should be plugged into your network router so that the CodeX has access to the internet and also the other computers or network storage for music streaming.

When the connection has successfully been made the CodeX will show an active network symbol on the display.



NO NETWORK CONNECTION



NETWORK CONNECTED

If your network connection or router is not located near your HiFi equipment then we recommend the use of power line network adapters. You simply plug one device into an available AC wall socket near your HiFi equipment and then another device into an AC wall socket near your network router. The network signal is carried over the AC power line wiring rather than having to run any additional cables. This system is very convenient but not suitable for every situation so you should check compatibility first.

Network example using power line adapters

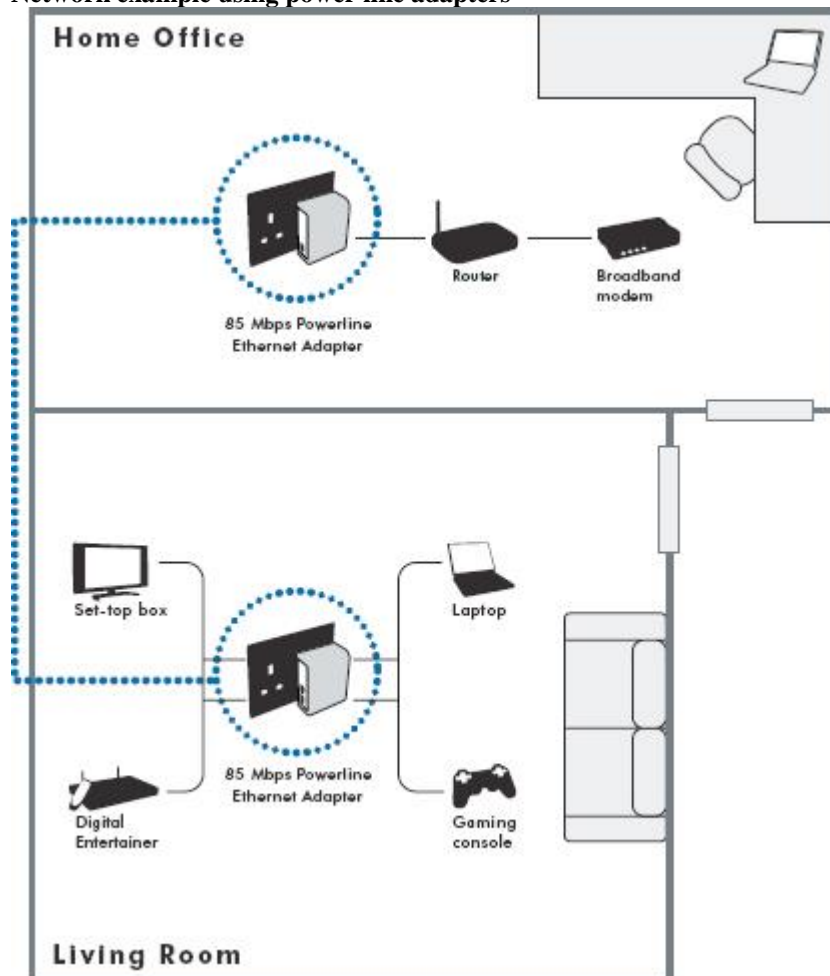

Network Settings

The CodeX is setup with the most commonly found network settings. However if you want to manually change these then go to settings, network, network setting and click the wired icon. You can then change from automatic mode to manually selecting an IP address and associated settings.

Media Server

Once the CodeX is has a network connection then it will automatically search for any available media servers available on your network. The media server is the software that will provide the music for the CodeX to play. Examples of this are Windows Media player, Twonky Media, Asset UPnP but many more are available for both Windows and Apple Mac computer systems and also tablet computers and mobile phones. Once the media server software is installed on the computer it will search and catalogue all the music on your hard drive and make that available to the CodeX.

If you don't wish to use your computer or have it switched on all the time then you may also decide to use a network attached storage drive more commonly called a NAS drive instead. These devices connect to the same network as the CodeX and have built in media server software that the CodeX can connect to. You simply copy all your music to the NAS drive and then leave it running all the time so that the CodeX can play music from it.

Web Browser Configuration

Network settings and the friendly network name of the CodeX can also be changed using the web browser menu. In the search bar of your web browser type the IP address of the CodeX to bring up the configuration menu. If you don't know the IP address use the settings menu on the CodeX to navigate to the network settings and then network info. This will show the connection settings and the IP address.

Output Connection

The CodeX has both single ended and balanced output connectors and an inbuilt volume control. You can connect directly to a power amplifier using either type of output connections.

Variable Output

The CodeX has a built in analogue volume control meaning that it can be directly connected to a power amplifier or amplified loudspeakers. Please use either the balanced XLR or RCA phono outputs.



Note: For optimum performance it is recommended that the balanced outputs are used where possible.

Digital Inputs

The CodeX has a 75 ohm bnc coax digital and also a USB input on the rear of the unit. You can use these to connect additional digital sources such as a CD transport or a computer and use the internal DAC inside the CodeX to play music. The digital input automatically switches on when the CodeX is not playing music. The USB input will take priority over the coax bnc which takes priority over the streaming input.

Before connecting your personal computer via an A to B type USB cable you will need to install the driver software provided on the enclosed CD (you can also download this from our website). Windows drivers files are contained in zip files, Apple Mac driver files are contained in dmg files. The CodeX will then appear as 'Chord Async USB 44.1KHz – 384KHz' in the soundcard settings. Select this to output your music to the Qute HD. On a Windows PC you should select kernel streaming in the playback software for native playback and DSD support. We recommend J.River Media Center or HQPlayer for the PC. On an Apple Mac the sample rate is automatically changed by the playback software. We recommend using Pure Music or Audirvana.

Digital Output

The CodeX has a 75 ohm bnc coax digital output which comes from the streaming engine. Anything played from the network will also be output via this connector. **It will not output digital signals from the bnc coax digital input or the USB input.**

Headphones

The CodeX features a ¾ inch headphone socket on the front panel. Once the headphones are inserted the output on the rear of the unit will automatically mute. You can listen to you music discretely using headphones and adjust the volume to suit.

Everyday use of your CodeX

Turning on your CodeX

Press the power button on the rear of the CodeX. Press again to switch off.

Turning on your CodeX from standby

Press the standby button on the remote control. Press again to switch into standby mode.

Boot Sequence

The CodeX will take about 30 seconds to load software so it is ready for use. During this time the Chord logo will be shown on the screen.



To play music from the digital input or USB input

If you have a digital source connected to the digital input or a computer connected to the USB input then you can just start playing music and use the volume control to set the listening level.

To play network audio from a media server

Using the front panel controls or the remote control select the media server menu and then select the media server you wish to use. Browse through the available albums and music tracks stored on the media server then select items to play.

To listen to an internet radio station

Using the front panel controls or the remote control select the internet radio menu. Browse or search through the available stations then select items to play.

adjusting the volume

Use the remote control buttons to adjust the volume. The volume range runs from 0 to 100 and is displayed on the CodeX display as you change the volume. The volume level is also always shown next to the clock on the display as the word Vol and a two digit level as shown in the example below.

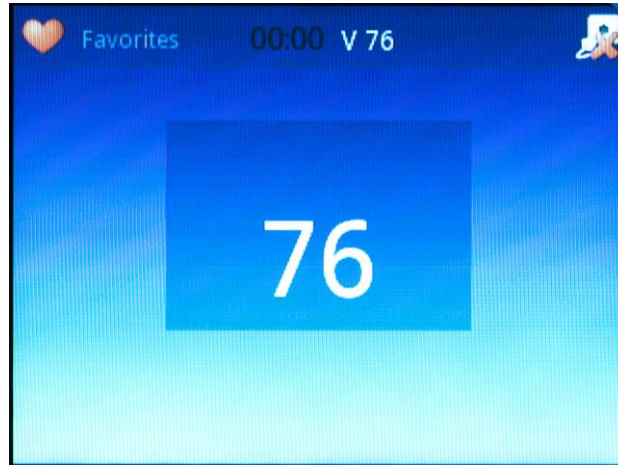

Volume display

User menus

Information Bar

The information bar appears at the top of nearly all screens on the CodeX. This gives important information regarding the current state of the CodeX.

















The following information will always appear:

- Clock
- Mute (if applicable)
- Random / Repeat 1 / Repeat All (when applicable)
- Play states (Play/Pause/Search) (will only appear during playback)
- Volume
- Network Status

Icons

Throughout the menus a number of icons have been specified. These are displayed in the information bar at the top of the screen.

	PLAY
	PAUSE
	FAST FORWARD
	FAST BACKWARDS
	MUTE
	REPEAT TRACK
	RANDOM
	REPEAT ALBUM
	FAVORITE
	MEDIA SERVER
	FOLDER
	SETTINGS
	NETWORK CONNECTED
	NETWORK DISCONNECTED

Menu pages

The CodeX is navigated via a menu system. All menus consist of a vertically scrolling list of menu items. A static highlight bar indicates which item is currently selected.

Home Menu

The Home Menu is the starting screen and will show menus for stored favourites, allow you to select your Media server, select the internet radio or make changes to the setup. Using the front panel control, remote control or Chord app software you can scroll up or down then press enter to select a menu.



Sub Menus

Sub menus of the CodeX contain icons for items which are playable (music, pictures) and for items which are folders or for setup information.

On the right side a scroll bar indicates the position in the complete list. The scroll bar fades out after a few idle seconds.

Mute

If the mute key is pressed the mute icon will appear in the info bar and the audio output will be muted. Press the mute key again to cancel the Mute.

When using a network music player or app to control the CodeX the mute icon may not be displayed but the audio output will still mute.

If power is lost or the device is powered down, the mute setting will not be remembered.

Playback

When a File is selected for playback the CodeX will launch either the Audio or Photo player. These will have a now playing display, which will give information on the current file playing. Playback will continue if the user navigates away from the Now Playing screen. Pressing *Home* on the remote whilst on the home menu will also take you to the Now Playing screen. To start playback firstly navigate to the media server where you music or photos are stored.

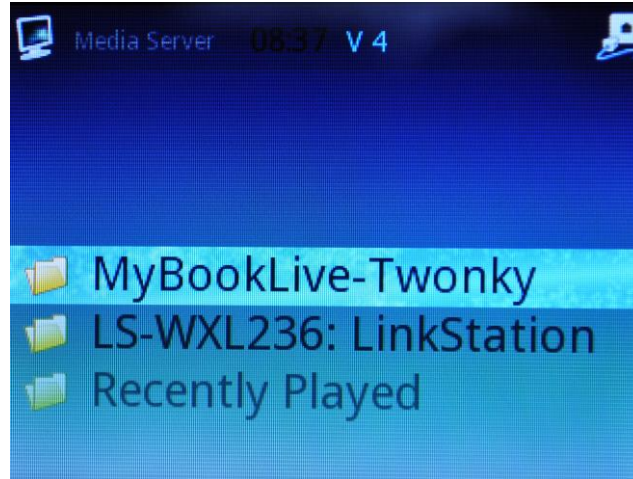

The available media servers will be listed. Select which one you want to stream your media from or choose recently played if you have played the track previously.

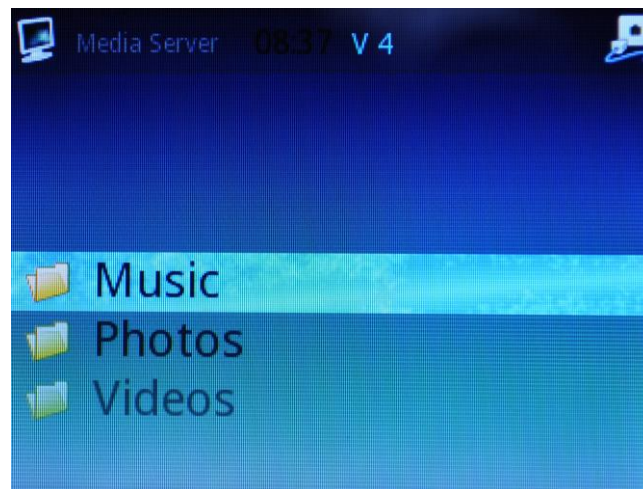

Choose to play either music or photos. Video is not supported.

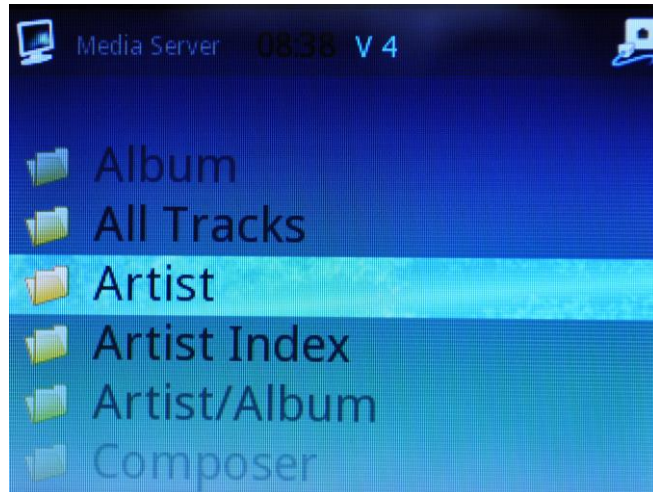

Depending on the media server settings you will be able to choose to sort and show your media with different options. Below we have chosen to search for music by Album.

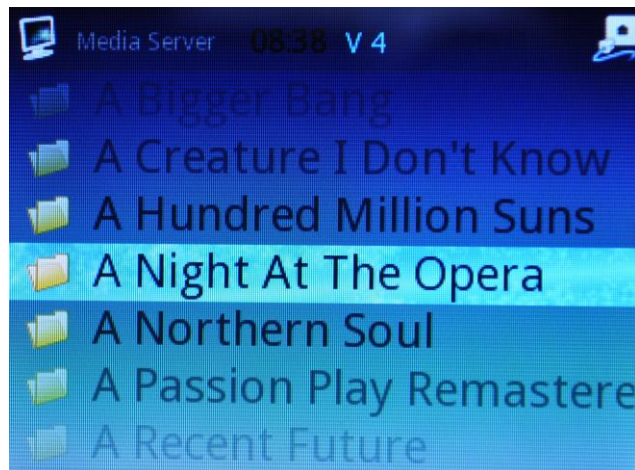

Select an album to play.

Audio Player

The audio Player 'Now playing' screen gives information regarding the current track being played.

This includes:

- Info bar
- Track
- Artist
- Album
- Album art
- Play / Pause / Search Icon
- Track time – x:xx of x:xx
- Track time bar

If there is no album art available the metadata will be drawn over the whole screen.

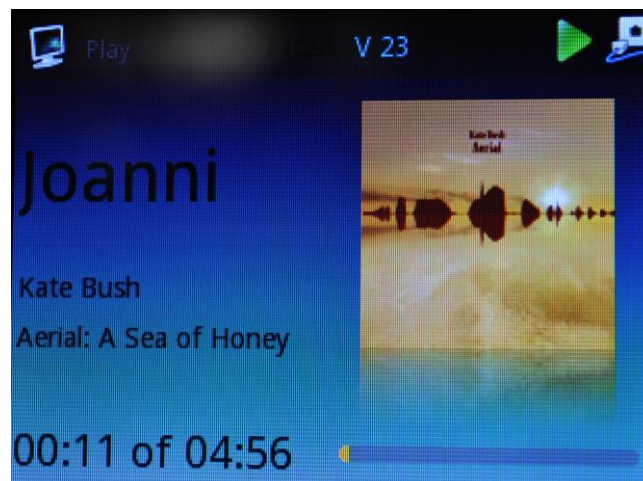

Photo viewer

The photo player plays back picture files full screen. There is normally no other information on the display. There are two playback modes.

- Slideshow mode
- Manual mode

When playback starts the photo viewer always defaults to slideshow mode. It will automatically scroll through the images every x seconds. This time is definable in the settings menu under slideshow options. The default is 10 seconds. If the end of the list is reached, the photo viewer will continue from the beginning of the same list. The user can enter manual mode by pressing *Play/Pause/Skip Forward/Skip Backward*. If they press *Play/Pause* again the photo viewer will return to slide show mode.

If the user presses *Skip Forward* or *Skip Back* the Photo viewer will enter Manual mode and *Skip Forward/Back* to the next photo. The user can then manually skip through the photos as desired. When using manual *skip forward/back*, a status icon will appear at the bottom of the display to feedback loading progress. The Skip Icon will only appear when using manual skip, not during automatic skip in slideshow mode.

Text Input

Text input is required for the some network settings and search functions.

- The characters will be selected using a barrel roll text entry system.
- The *Right* key will move to the next character
- The *Left or back* key will move to the previous character
- The *OK* button will confirm the entered value
- *Up/Down* will scroll through the characters

Settings Menu

From the main menu you can enter the settings menu to make changes to the CodeX configuration.

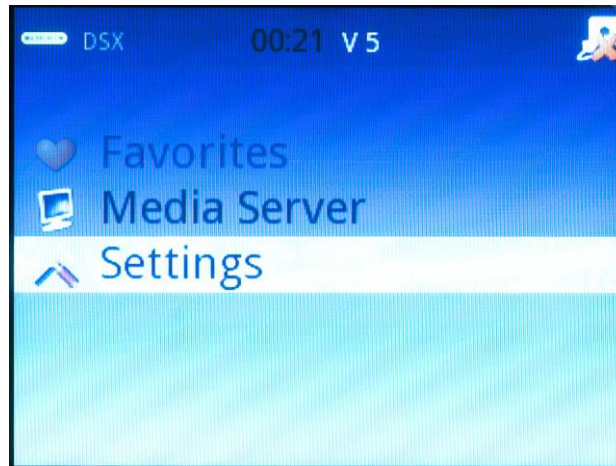

There are several options to make changes to the network, time, user interface, playback or general configuration.

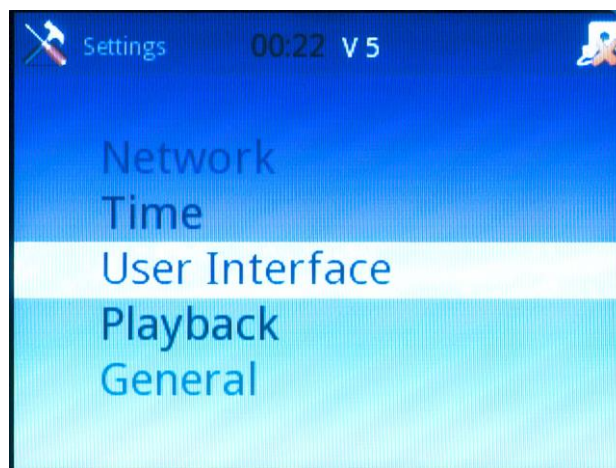

Network

The network settings menu gives you options to change your type of connection from automatic mode to manual if you want to use your own static IP address or use a proxy server. In nearly all cases automatic mode will be the best option.

You can also see the current network information including the IP address allocated to the CodeX – this is useful if you want to use the web configuration or if you need to use control software that requires the IP address to be known.

If you have a media server that you want to set as the default so your media is always chosen from the same server then you can use the Default UPnP server menu. Select a default server from a list of all the media servers available on your network.

You can change the friendly network name. By default this is set to CodeX. (This can only be changed when nothing is playing)

Time

The time menu allows you to make changes to the time zone and switch daylight savings mode on or off.

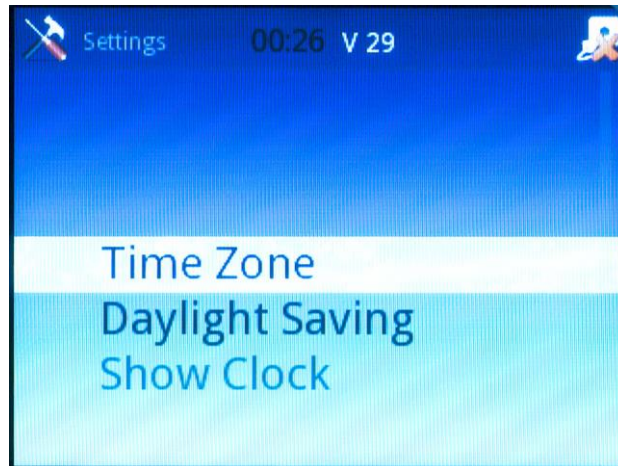

User Interface

The user interface has 4 themes to choose from and also the option to switch the display off after a period of time so nothing is displayed.

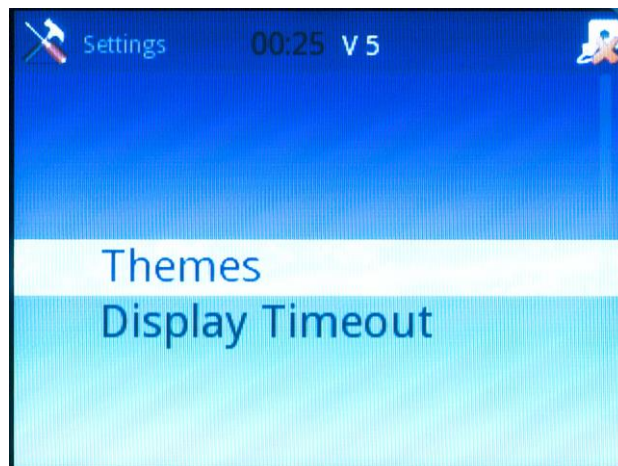

Playback

The playback menu allows you to select repeat mode, shuffle mode or the image slideshow transition time between images. (You can also select repeat and shuffle modes using the remote control button)

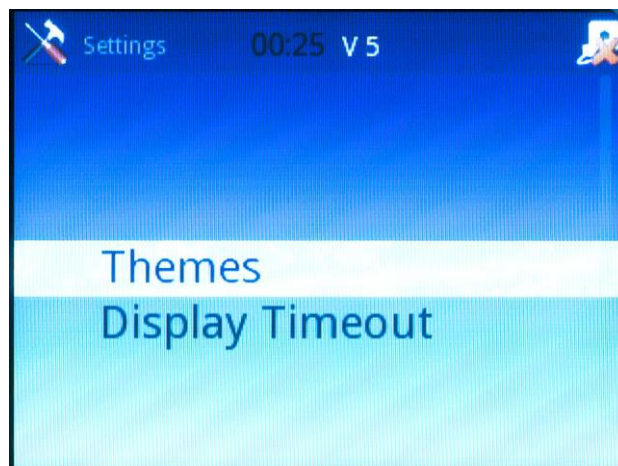

General Menu

This menu will allow you to reset the CodeX back to factory defaults, update the software and show information about the product and legal information.

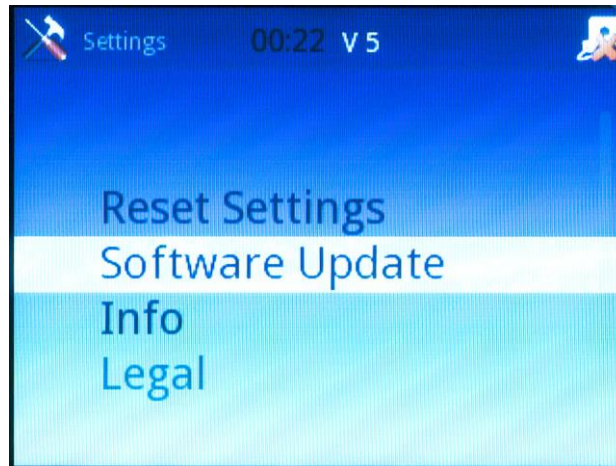

Favourites Menu

When playing a particular media file you can add this to your favourites menu to make it easier to locate for future playback. Whilst playing press the favourite key on the remote control to add an entry to the menu.

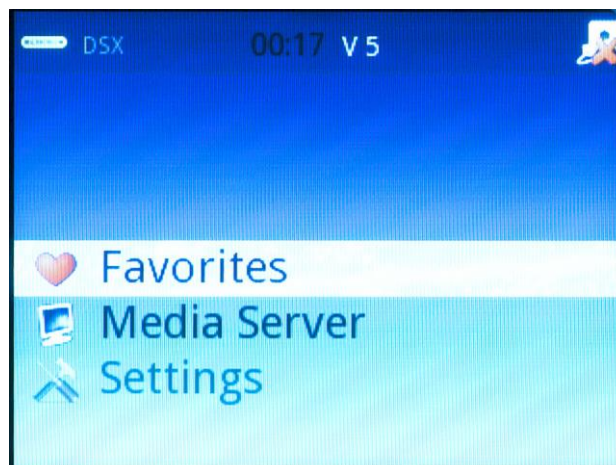

From the home page select the Favourite menu to find and play your stored media files. To delete an entry just press the Mem key on the remote control.

Using the front panel control

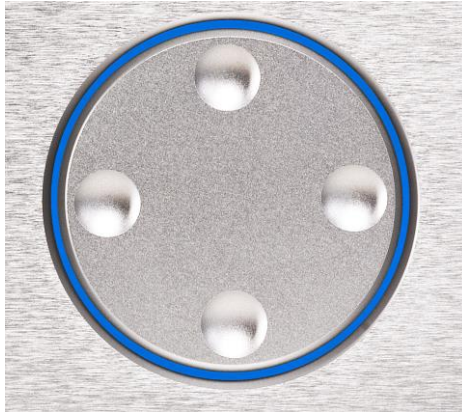

The front panel control disc allows you to navigate through the menus and select items. As well as the normal up, down, left and right functions you can also select each item by pressing down hard on any button. Each function is represented by a different colour blue, yellow, red, green or white.

Using the remote control

The CodeX is supplied with a remote control that can be used to fully control it. The main functions are listed below:-

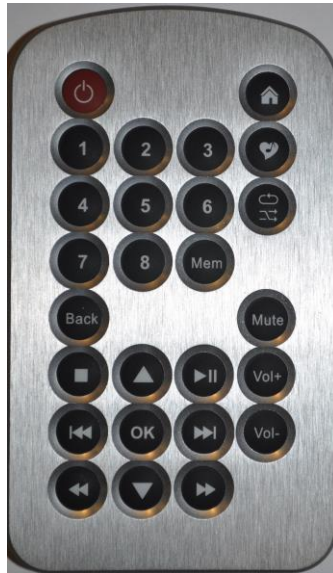

Standby. Press to switch the unit into standby mode. Press again to switch back on.



Home key. This will show the home menu. Press again to show the current playing track.



Favourite key. Press to add a media file to the favourite menu.



Repeat all, repeat one and shuffle key.



Delete memory key. This removes entries in the favourite menu.



Number keys. Not used.



Mute and volume keys.



Navigation keys allow you to use the menus. These keys also work to track forward and back, stop, play, pause and also fast forward or fast back any track.



The back key will take you back through the menus or text entry.

Playing music from an portable device app or desktop program

We have our own custom Chord app available from the Apple iTunes store and also the Google Play store. This is available for iPhone, iPad and Android devices. Search for Chord Electronics. This will allow remote control of the Codex via your portable product. The app mimics the front panel display and so the menus and functions that you see on the display of the CodeX will also be shown on the Chord app software. Music selection and the volume can all be controlled remotely from the Chord app.

You can also use any other app or computer software that supports UPnP or DLNA control. Refer to the manual supplied with the app or program to search for connected network media renderers or players. The CodeX will be shown as a network player and can be selected for use. Browse through the library of connected music sources from your computer or connected network drive and choose music to play. You can use the volume control button in the app or program to directly increase or decrease the level.

As well as our own app the CodeX has also been tested with Songbook, 8Player, PlugPlayer, BubbleUpnp apps or desktop computer programs such as J.River Media Centre.

Maintenance

cleaning

To clean finger marks and other blemishes from your amplifier spray clear glass cleaner onto a soft lint free cloth and then use the cloth to gently clean your amplifier.

changing the batteries in the remote control

Simply push the button on the bottom of your remote control to release the battery cover. Replace with one new CR2025 button cell battery.

servicing

There are no user serviceable parts in your Chord amplifier, and it should only be serviced by Chord Electronics Limited or their expressly approved Service Agents.

Frequently asked questions

why aren't any of the remote control buttons working?

Check and replace the battery. The battery compartment can be opened from the bottom of the unit and requires a CR2025 battery.

I've connected all the wires up but I can't hear any sound?

Ensure that the mute is not selected and the volume is turned up.

why is there humming coming from the loudspeakers?

Check that you've earthed the unit. The interconnects need to be properly screened and placed away from mains cables. Interference can be reduced by using balanced inputs and outputs instead of RCA phono types.

the sound coming from the loudspeakers is distorted

Check that the speakers are connected properly. It may be that the volume is turned up too loud for your speakers.

Product Specification

HARMONIC DISTORTION	103dB
CHANNEL SEPARATION	> 115dB @ 1KHz
DYNAMIC RANGE	118dB
NETWORK INPUT	1 x RJ45 100 base T Ethernet
DIGITAL INPUT	1 x 75 ohm BNC, 1x USB B type automatic switching
SUPPORTED FILE FORMATS	wma-9, mp3, AAC, Ogg Vorbis ALAC, AIFF (96KHz) FLAC, WAV up to 192KHz. 64FS DSD (DoP) 128FS DSD (DoP), 352.8KHz and 384KHz DXD via USB only
ANALOGUE OUTPUTS	Stereo RCA Phono and balanced XLR Volume Controlled Outputs
SUPPORTED SAMPLE FREQUENCIES	44.1 to 192KHz via Ethernet and Coax BNC 44.1 to 384KHz via USB
LINE LEVEL OUTPUT	4V rms. Balanced. 2V rms. unbalanced
OUTPUT IMPEDANCE	75Ω (short circuit protected)
DIMENSIONS IN MM	338 x 60 x 145mm (Width x Height x Depth)
POWER CONSUMPTION	20W
OPERATING VOLTAGE	85 – 270V AC (50-60Hz) auto switching
WEIGHT	7 Kg



Chord Electronics limited

The Pumphouse
Farleigh Bridge
Farleigh Lane
East Farleigh
Kent ME16 9NB

Tel: +44 (0)1622 721444

Fax: +44 (0)1622 721555

Email: sales@chordelectronics.co.uk

<http://www.chordelectronics.co.uk>

